

ACTION CAN[®]

By CRC Industries



PRODUCT GUIDE

ISSUE 5



NEVER ASK A PROFESSIONAL TO USE ANYTHING ELSE!

LUBRICANTS • CLEANERS • METAL WORKING • ANTI-CORROSION & PAINTS • WORKSHOP ADDITIONS

QUICK REFERENCE GUIDE

AC-90 Multi-Purpose Lubricant	<u>9</u>	IPA Electronic Cleaning Solvent	<u>21</u>
AMAZE Dash & Bumper Cleaner	<u>18</u>	LD-90 Gas Leak Detector	<u>33</u>
AS-90 Welders Anti-Spatter Spray	<u>26</u>	LM-90 Line Marking Paint	<u>34</u>
AT-90 Air Tool Lubricant	<u>34</u>	LW-90 Professional Multi-Purpose Wipes	<u>21</u>
BC-90 Brake & Clutch Cleaner	<u>18</u>	MZ-90 Maximum Zinc Coating	<u>30</u>
BD-90 Belt Dressing Spray	<u>10</u>	PD-90 Power Duster	<u>22</u>
BLUE CRYSTAL Glass & Hard Surface Cleaner	<u>19</u>	RP-90 Rapid Penetrating Oil	<u>13</u>
CD-90 Chain & Drive Lubricant	<u>10</u>	RX-90 Red Oxide Anti-Rust Primer	<u>30</u>
CG-90 General Purpose Clear Grease With PTFE	<u>11</u>	SA-90 Contact Spray Adhesive	<u>35</u>
CS-90 Copper Anti-Seize	<u>11</u>	SC-90 Stainless Steel Cleaner	<u>22</u>
CT-90 Cutting & Tapping Fluid	<u>25</u>	SL-90 Lubricating Oil with PTFE	<u>14</u>
DM-90 Dry Moly Lubricant	<u>12</u>	SP-90 Silicone Lubricant Spray	<u>14</u>
DRY-PTFE Lubricant & Release Agent	<u>12</u>	SUPERROL Anti-Rust Fluid	<u>31</u>
DS-90 Multi-Surface Decontamination Spray	<u>19</u>	TF-90 Fast Drying Cleaning Solvent	<u>17</u>
EC-90 Fast Drying Contact Cleaner	<u>20</u>	TW-90 Heavy Duty Textured Wipes	<u>23</u>
FC-90 Anti-Static Foam Cleaner	<u>20</u>	WB-90 Water Based Anti-Spatter	<u>27</u>
FF-90 Flaw Finder Non-Destructive Testing Kit	<u>26</u>	WG-90 White Calcium Grease	<u>15</u>
FR-90 Freeze Release Penetrating Oil	<u>13</u>	ZG-90 Rapid Dry Galvanise	<u>29</u>

VALUE-ADDED



BRAND HERITAGE & TRUST

Action Can is a globally recognised brand of professional-grade chemicals that give right-first-time results, every time. With a heritage stretching back over 35-years, Action Can products are the first choice for engineers around the world: "Never Ask A Professional To Use Anything Else!"



UNIQUE CAN IMAGES

The instantly recognisable and unique graphic illustrations on all Action Can products help users and choosers to identify what the product does; reducing selection confusion quickly, regardless of local/native language.



LOCAL SALES MANAGERS

Our regionally based, in-house trained Territory Managers are the first port of call for product enquiries, technical support, point of sale/merchandising and on-site training. With detailed product knowledge, backed up by in-house technical and supply-chain colleagues, they are the brand heroes of Action Can.



MULTI-LANGUAGE CANS

All Action Can products are available with six languages on the labels: English, French, German, Polish, Greek and Portuguese. Our multi-language product labels allow our distribution partners to supply international markets and assist non-English speakers in identifying product features/safety precautions.



PROFESSIONAL FILL SIZE

Action Can products have been developed to meet the needs of professional users with a large, 500ml nett fill – because we understand the frustration you have when a can runs out part-way through a job!



INSTANT SDS

24/7/365 availability of safety data sheets (SDS) via our website: www.actioncan.com. Hosted by our international servers, Action Can provides automatic up-to-date safety data sheets – allowing users the peace-of-mind that these essential documents are always up-to-date.



TECHNICAL SUPPORT

In-house technical and laboratory teams for specific application enquiries or technical information. Got a problem but not sure where to turn for answers? Give the Action Can team a call!



LISTENING TO OUR CUSTOMERS

The Sales and Marketing Teams at Action Can continually evaluate the product range and service mix to ensure we meet our customers' and users' needs. Product feedback is always welcomed, and has resulted in a number of additions to the range, such as PD-90 Power Duster and the FF-90 Flaw Finder NDT Kit.

Whether it is a novel or unique application that requires a product innovation, or simply an idea for an existing product, we are always open to your suggestions.



FREE PRODUCT SAMPLES

We believe in the quality of our products, but don't just take our word for it – try them for yourself! Free product samples are available for user application testing, simply request them from the Action Can Sales Managers. "Tested, Trusted and Approved."

OUR STORY

In 1985 Action Can launched AC-90 Multi-Purpose Lubricant onto the UK engineering market. Its success led to the development of an entire Action Can range. In the three decades since, Action Can has become established as one of the UK's leading manufacturers of professional grade maintenance chemicals. In 2016 Action Can was acquired by CRC Industries UK Ltd, specialists in industrial chemical product development and manufacture for over 70-years. Research and development continues with a variety of pack options and further product range expansion.

Our flagship multi-purpose lubricant "AC-90" has set the standard for the 'all-in-one' product category: effectively lubricating, penetrating, displacing moisture, protecting against corrosion and cleaning: "In The Right Hands It's A Power Tool!"

The Action Can product range is sold exclusively through wholesale and distributor channels, continuing to grow from a handful of core products to an ever-expanding engineering/professional product range.

Now part of the CRC Industries group of companies, Action Can provides a comprehensive range of first-class products backed up by in-house technical facilities, customer service, with dedicated sales and marketing teams. Action Can's quality control and environmental systems not only ensure first-class products but are also continually tested in laboratory and everyday applications to ensure consistency backed up by full ISO 9001:2015 and ISO 14001:2015 accreditations.

"Right First Time Results, Every Time."

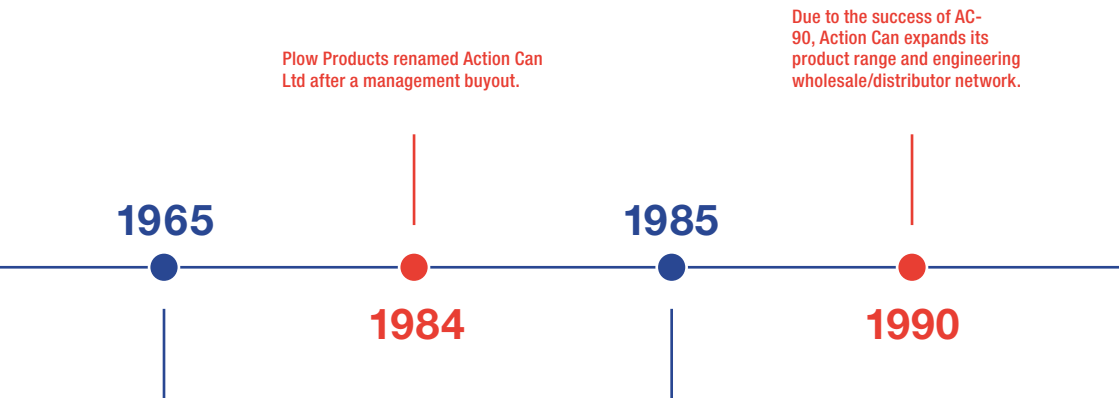

Plow Products Ltd, a division of (LMI) London & Midland Industries were awarded the contract for WD-40 distribution license for Europe, Asia, Africa and the Middle East.

WD-40 Europe established taking distribution in-house. Action Can use technical know-how to create "AC-90 Multi-Purpose Lubricant" ensuring continuity of supply.

OUR PRODUCTS

Developed to meet the exacting requirements of professional engineers and manufactured in our UK and European facilities, the Action Can product range offers product choice, proven performance and full in-house quality control. Our products hold many approvals, and we aim to meet professional grade standards every time. **“Tested, Trusted and Approved.”**

OUR FACTORY

Our manufacturing operations consist of modern, automated aerosol filling lines, carefully selected raw materials and our considerable experience in blending formulations with independent quality assurance. We continue to invest in new equipment and site infrastructure to ensure our long-term commitment to product development and increased capacity for operational excellence. Action Can offers product reliability and the peace of mind that every can works just as well as the last.

OUR CUSTOMERS

Action Can supplies a wide range of products into distribution partners whom operate in multiple market sectors:

- Fastener and Fixing industry
- Engineering
- Trade & Pro DIY
- Agriculture & Construction
- Electrical industry

We believe in building long-lasting business partnerships founded on trust, cooperative solution delivery and quality: **“Never Ask A Professional To Use Anything Else.”**

Action Can continues to evolve and expand its product range, adding products such as AC-90 TwinSpray and a new AC-90 5L with Trigger Spray pack. Product branding updated and additional distributor support options added.

2016

2020

2018

Action Can Ltd acquired by CRC Industries UK Ltd, a global leader in the production of specialty chemicals for maintenance, repair and operational professionals. Territory Management headcount increased and investment in brand prioritised.

A record year for product development and brand added-value...

PRODUCT SELECTION GUIDE

• LUBRICANTS •

		PRODUCT	PAGE
	MULTI-PURPOSE LUBRICANT	AC-90	<u>9</u>
	Quick fix, all-in-one can solution TWINSPRAY™		
	OILS		
	Chain & Drive Lubricant	CD-90	<u>10</u>
	Freeze Release Penetrating Oil	FR-90	<u>13</u>
	Rapid Penetrating Oil TWINSPRAY™	RP-90	<u>13</u>
	Lubricating Oil With PTFE TWINSPRAY™	SL-90	<u>14</u>
	SILICONE		
	Silicone Lubricant Spray TWINSPRAY™	SP-90	<u>14</u>
	DRY FILM		
	Belt Dressing Spray	BD-90	<u>10</u>
	Dry Moly Spray	DM-90	<u>12</u>
	PTFE Lubricant & Release Agent TWINSPRAY™	DRY PTFE	<u>12</u>
	ANTI-SEIZE & ASSEMBLY		
	Copper Anti-Seize	CS-90	<u>11</u>
	GREASES		
	General Purpose Clear Grease	CG-90	<u>11</u>
	General Purpose White Grease	WG-90	<u>15</u>

● CLEANERS ●

ENGINEERING & ELECTRO-MECHANICAL

- Fast Drying Solvent
TWINSPRAY™ **TF-90** **17**
- Brake Cleaner **BC-90** **18**
- Contact Cleaner **EC-90** **20**
- Electrical Solvent **IPA** **21**
- Powerful Air Duster **PD-90** **22**
- Stainless Steel Cleaner **SC-90** **22**

GENERAL CLEANING

- Vehicle Dashboard Cleaner **AMAZE** **18**
- Glass & Hard Surface Cleaner **Blue Crystal** **19**
- Surface Decontamination Spray **DS-90** **19**
- Anti-Static Foam Cleaner **FC-90** **20**

HAND CLEANING

- Professional Multi-Purpose Wipes **LW-90** **21**
- Heavy Duty Textured Wipes **TW-90** **23**

● METAL WORKING ●

- Metal Working, Cutting & Tapping
TWINSPRAY™ **CT-90** **25**
- Solvent Anti-Spatter **AS-90** **26**
- NDT Flaw Finder Kit **FF-90** **26**
- Water Based Anti-Spatter **WB-90** **27**

● ANTI-CORROSION & PAINTS ●

- 2-in-1 Anti-Rust Paint **ZG-90** **29**
- Maximum Zinc Coating **MZ-90** **30**
- Red Oxide Primer **RX-90** **30**
- Long-Term Anti-Rust Fluid **Supertrol** **31**

● WORKSHOP ADDITIONS/SPECIALISTS ●

- Gas Leak Detection **LD-90** **33**
- Air Tool Lubricant **AT-90** **34**
- Line Marking Paint **LM-90** **34**
- Contact Spray Adhesive **SA-90** **35**

LUBRICANTS



AC-90 MULTI-PURPOSE LUBRICANT

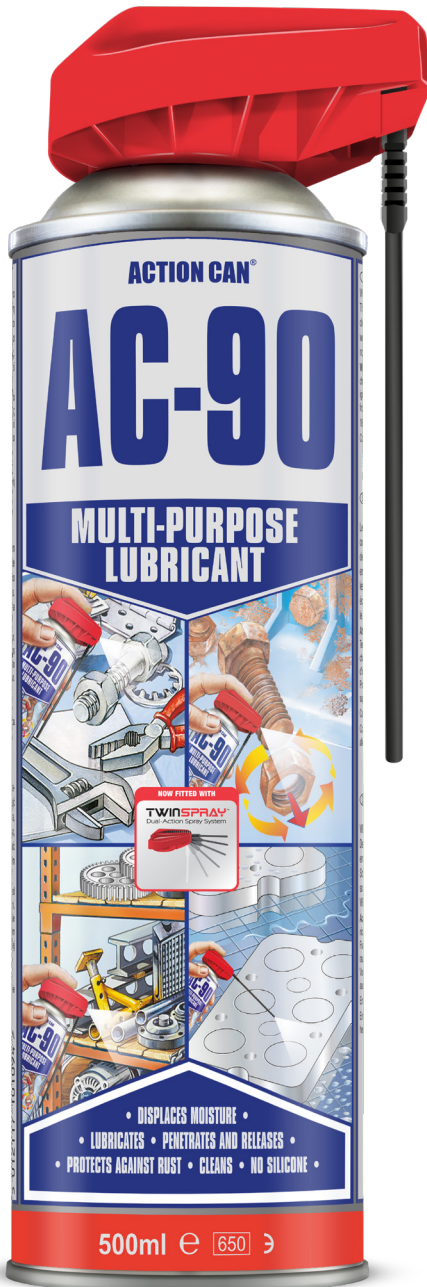

KEY FEATURES

- Displaces moisture and eliminates damp induced faults
- Lubricates moving parts to keep them working smoothly and efficiently
- Rapidly penetrates and releases seized parts and fasteners
- Excellent short-term corrosion protection
- Cleans surfaces effectively, removing heavy oils, waxes and grime
- Available as NSF H1 registered version for use in the food and beverage sector

APPLICATION AREAS

Quick fix instant solution for professional engineers. Lubricates practically everything such as fittings, locks, tools and sliding metal-to-metal parts. Releases rusted threaded fasteners. Cleans industrial equipment and tools.

MARKET SECTORS:

FASTENERS & FIXINGS

ENGINEERING

TRADE/PRO-DIY

ELECTRICAL MRO

AGRICULTURE

CRC CODE	SIZE	PER BOX
33179	500ml Aerosol TwinSpray LPG	15
32769	425ml Aerosol LPG	15
32766	500ml Aerosol LPG	15
32768	250ml Aerosol CO ₂	15
32767	500ml Aerosol CO ₂	12
32779	500ml Aerosol Food Grade LPG	15
33156	5L Pack + Trigger Spray	1
32852	5L Can	1
32853	25L Drum	1

For further product info:
www.actioncan.com/product/ac-90/ 

BD-90 BELT DRESSING SPRAY



KEY FEATURES

- Rapidly restores grip to all types of belts
- Reduces belt slippage and increases pulling power
- Inhibits hardening and glazing of the belt
- Eliminates belt squeak
- Ideal for use on belts in humid or outdoor environments

APPLICATION AREAS

BD-90 can be used on all types of flat, round or v-belts made from rubber, leather, plastic or fabric found on a wide range of machinery including conveyors, compressors, pumps, generators and lift trucks.

MARKET SECTORS:

- AGRICULTURE**
- ENGINEERING**
- TRADE/PRO-DIY**

CRC CODE	SIZE	PER BOX
32805	500ml Aerosol	15

For further product info:
www.actioncan.com/product/bd-90/

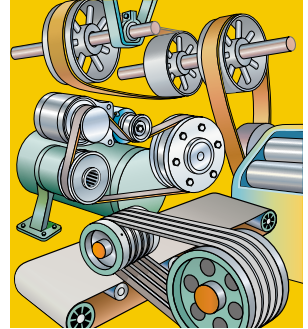

CD-90 CHAIN AND DRIVE LUBRICANT



KEY FEATURES

- Lubricant with extreme pressure additives for all types of chain and drive components
- Penetrates and lubricates chain linkage upon application
- Protects chain and drive components from wear and corrosion, even in damp conditions
- Effective temperature range -15°C to +150°C
- Also available as NSF H1 registered for use in the food and beverage sector

APPLICATION AREAS

Suitable for use on numerous types of chains, chain driven belts and drives used in many different industries and areas, including packaging machinery, forklift trucks, escalator mechanisms, cement and quarry plant and papermaking machinery.

MARKET SECTORS:

- ENGINEERING**
- AGRICULTURE**
- FASTENERS & FIXINGS**
- ELECTRICAL MRO**
- TRADE/PRO-DIY**

CRC CODE	SIZE	PER BOX
32775	500ml Aerosol	15
32784	500ml Aerosol Food Grade	15

For further product info:
www.actioncan.com/product/cd-90/

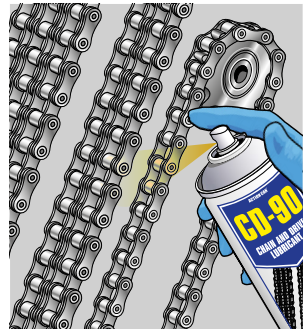

CG-90 GENERAL PURPOSE CLEAR GREASE WITH PTFE



KEY FEATURES

- General purpose EP clear grease
- Contains PTFE to enhance lubrication performance
- Thermally stable with an operating temperature range from -12°C to $+180^{\circ}\text{C}$
- Locks-out moisture and prevents corrosion

APPLICATION AREAS

Use for the lubrication of a wide variety of bearings, hinges, small gears and sliding metal parts.

MARKET SECTORS:

- ENGINEERING**
- TRADE/PRO-DIY**
- ELECTRICAL MRO**
- FASTENERS & FIXINGS**
- AGRICULTURE**

CRC CODE	SIZE	PER BOX
32799	500ml Aerosol	15

For further product info:
www.actioncan.com/product/cg-90/ 

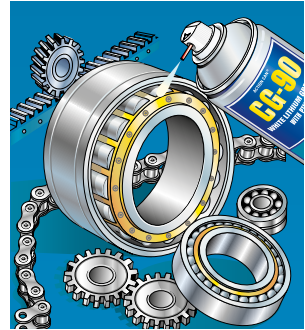

LUBRICANTS

CS-90 COPPER ANTI-SEIZE



KEY FEATURES

- Reduces friction and wear
- Enables easy assembly and disassembly
- Prevents seizing, galling and stripping of threaded fasteners
- Non-hardening and non-dripping
- Protects fasteners against harsh corrosive environments
- Water resistant
- Free from lead and silicone

APPLICATION AREAS

Use as an effective anti-seize lubricant for bolts, nuts, pins, screw connections on hydraulic equipment, brakes guides, brake adjusters, spark plugs, splines, wheel bolts, flanges and flange seals, pipeline connections, exhaust screw connections, mechanical linkages, sliding sleeves and shafts.

MARKET SECTORS:

- FASTENERS & FIXINGS**
- TRADE/PRO-DIY**
- AGRICULTURE**
- ENGINEERING**
- ELECTRICAL MRO**

CRC CODE	SIZE	PER BOX
32804	500ml Aerosol	15
32843	500g Compound Tub	12

For further product info:
www.actioncan.com/product/cs-90/ 

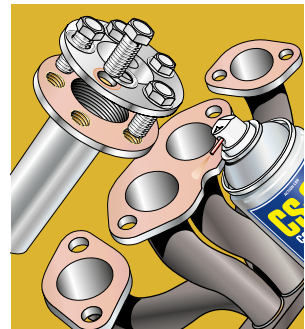

DM-90 DRY MOLYBDENUM DISULPHIDE LUBRICANT



KEY FEATURES

- Excellent extreme pressure lubricant
- Contains concentrated Molybdenum Disulphide (MoS₂)
- Prevents galling, seizing and sticking; reduces friction and wear
- Provides a tough, durable, resin-bonded dry film coating
- Ideal for use in harsh, corrosive, dusty and 'challenging' environments

APPLICATION AREAS

Use DM-90 where a dry-film lubricant is specified, or where 'difficult' operating conditions are normal, e.g. high temperature, high load, slides, rollers, wheels, gears, chains & hoists.

MARKET SECTORS:

- ENGINEERING
- FASTENERS & FIXINGS
- AGRICULTURE
- ELECTRICAL MRO

CRC CODE	SIZE	PER BOX
32798	500ml Aerosol	15

For further product info:
www.actioncan.com/product/dm-90/ 

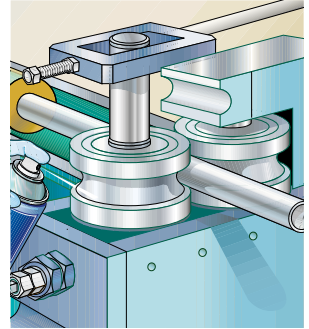

DRY PTFE LUBRICANT AND RELEASE AGENT



KEY FEATURES

- Dry film lubricant and release agent
- Resists water, oil and solvents
- Dry, durable coating to minimise wear
- Effective temperature range -100°C to +200°C
- Use where a wet film lubricant cannot be tolerated
- NSF H1 registered for use in the food and beverage sector

APPLICATION AREAS

Highly effective dry lubricant with superior 'slip' properties. Use on chutes, slides and pins, etc where a wet or oily lubricant cannot be used. Particularly effective in low load, high speed applications. Use on saw blades (cutting timber) as an anti-stick treatment that reduces sap adhesion or moisture sticking.

MARKET SECTORS:

- AGRICULTURE
- ELECTRICAL MRO
- FASTENERS & FIXINGS
- ENGINEERING
- TRADE/PRO-DIY

CRC CODE	SIZE	PER BOX
33323	500ml Aerosol TwinSpray	15
32786	500ml Aerosol	15

For further product info:
www.actioncan.com/product/ptfe/ 

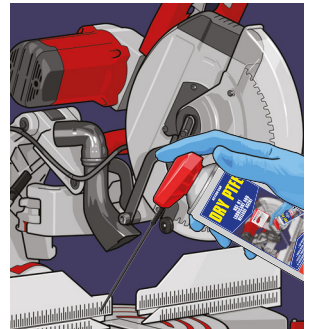

FR-90 FREEZE RELEASE PENETRATING OIL

NEW!



KEY FEATURES

- Lubricant rapidly penetrates rust
- Freeze shocks rust down to -40°C , cracking surface rust (dependent on starting ambient temperature)
- Creates micro-fissures in rust
- Fitted with a 360° valve for all angle use
- Suitable for use on all metal components
- Does not contain silicone

APPLICATION AREAS

FR-90 can be used to release seized/rusted nuts and bolts, valves, heating pumps, immersion heater and fused parts.

MARKET SECTORS:

- FASTENERS & FIXINGS**
- ENGINEERING**
- TRADE/PRO-DIY**
- AGRICULTURE**

CRC CODE	SIZE	PER BOX
33309	500ml Aerosol	15

For further product info:
www.actioncan.com/product/fr-90/ 

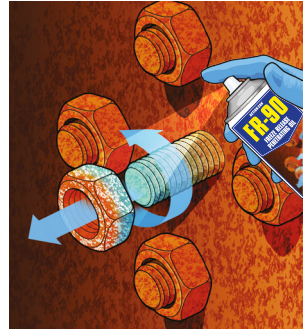

LUBRICANTS

RP-90 RAPID PENETRATING OIL

NEW!

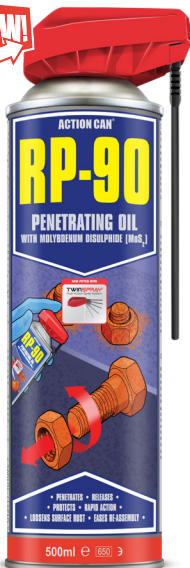

KEY FEATURES

- Excellent penetrating power
- Rapid release capability
- Protects against rust and corrosion
- Loosens surface rust/flash rusting
- Contains 'moly' for easy reassembly
- Does not contain silicone

APPLICATION AREAS

The fastest solution for freeing nuts, bolts, screws, studs, pins, valves, machine parts, pipe couplings and pulleys, whether seized through over-tightening, corrosion, heat, or bonding. RP-90 can also be used for cleaning rusted surfaces of moulds, dies and heavy tools and for softening or removing carbon deposits.

MARKET SECTORS:

- FASTENERS & FIXINGS**
- ENGINEERING**
- TRADE/PRO-DIY**
- ELECTRICAL MRO**
- AGRICULTURE**

CRC CODE	SIZE	PER BOX
33320	500ml Aerosol	15
32797	500ml Aerosol	15

For further product info:
www.actioncan.com/product/rp-90/ 



SL-90 LUBRICATING OIL WITH PTFE

NEW!

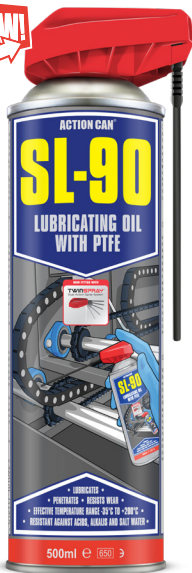

KEY FEATURES

- Multi-purpose lubricating oil
- Wide operating temperature range –35°C to +200°C
- EP additives improve high load-carrying capacity
- Multi-viscosity capability with good anti-fling properties
- Resistant to water, steam, acid and alkalis

APPLICATION AREAS

Use on manual handling equipment: forklifts, chains, jacks and pallet trucks; logistics and warehousing applications: guide rails, chutes, slides, conveyors; on agricultural equipment; power transfer components: gears with high point-of-contact temperatures, open gears, and sealed bearings and as a high-performance multi-purpose lubricating oil.

MARKET SECTORS:

**ENGINEERING | ELECTRICAL MRO
TRADE/PRO-DIY | AGRICULTURE
FASTENERS & FIXINGS**

CRC CODE	SIZE	PER BOX
33321	500ml Aerosol TwinSpray	15
32796	500ml Aerosol	15

For further product info:

www.actioncan.com/product/sl-90/ 

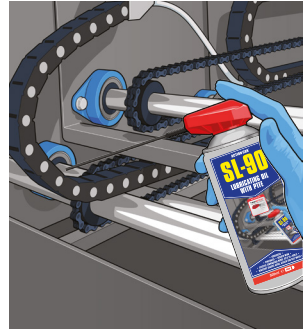

LUBRICANTS

SP-90 SILICONE LUBRICANT SPRAY

NEW!



KEY FEATURES

- Dry film precision silicone lubricant
- Lubricates and reduces friction
- Effective temperature range –50°C to +200°C
- Solvent free formulation
- Safe for use on all metals, most rubbers and most plastics
- Also available as NSF H1 registered for use in the food and beverage sector

APPLICATION AREAS

Useful throughout the electrical, plastic processing, plumbing, metal working and sewing/upholstery industries. Lubricates plastic to plastic surfaces, sewing needles and O-rings – assists with the installation of cabling. Protects against water ingress.

MARKET SECTORS:

**TRADE/PRO-DIY
ENGINEERING
ELECTRICAL MRO
FASTENERS & FIXINGS
AGRICULTURE**

CRC CODE	SIZE	PER BOX
33319	500ml Aerosol TwinSpray	15
32773	500ml Aerosol	15
32785	500ml Aerosol Food Grade	15

For further product info:

www.actioncan.com/product/sp-90/ 



WG-90 WHITE CALCIUM GREASE

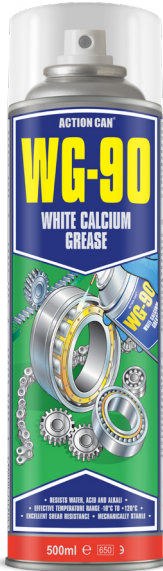

KEY FEATURES

- NLGI grade 2 general purpose grease
- Excellent water, acid and alkali resistance
- Effective temperature range -10°C to +120°C
- Mechanically stable with excellent shear resistance
- Enhanced anti-corrosion and protection properties
- Extremely low water-washout

APPLICATION AREAS

Provides tenacious lubrication of moving parts exposed to moisture, rain, spray, and other harsh or corrosive environments. Use on car door hinges, exposed gears and outdoors moving parts.

MARKET SECTORS:

- AGRICULTURE**
- ELECTRICAL MRO**
- FASTENERS & FIXINGS**
- ENGINEERING**
- TRADE/PRO-DIY**

CRC CODE	SIZE	PER BOX
32801	500ml Aerosol	15

For further product info:
www.actioncan.com/product/wg-90/

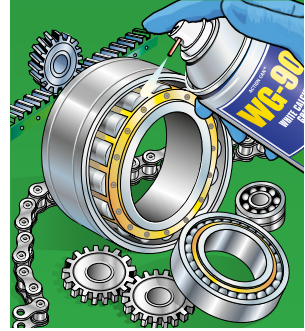

LUBRICANTS

CLEANERS

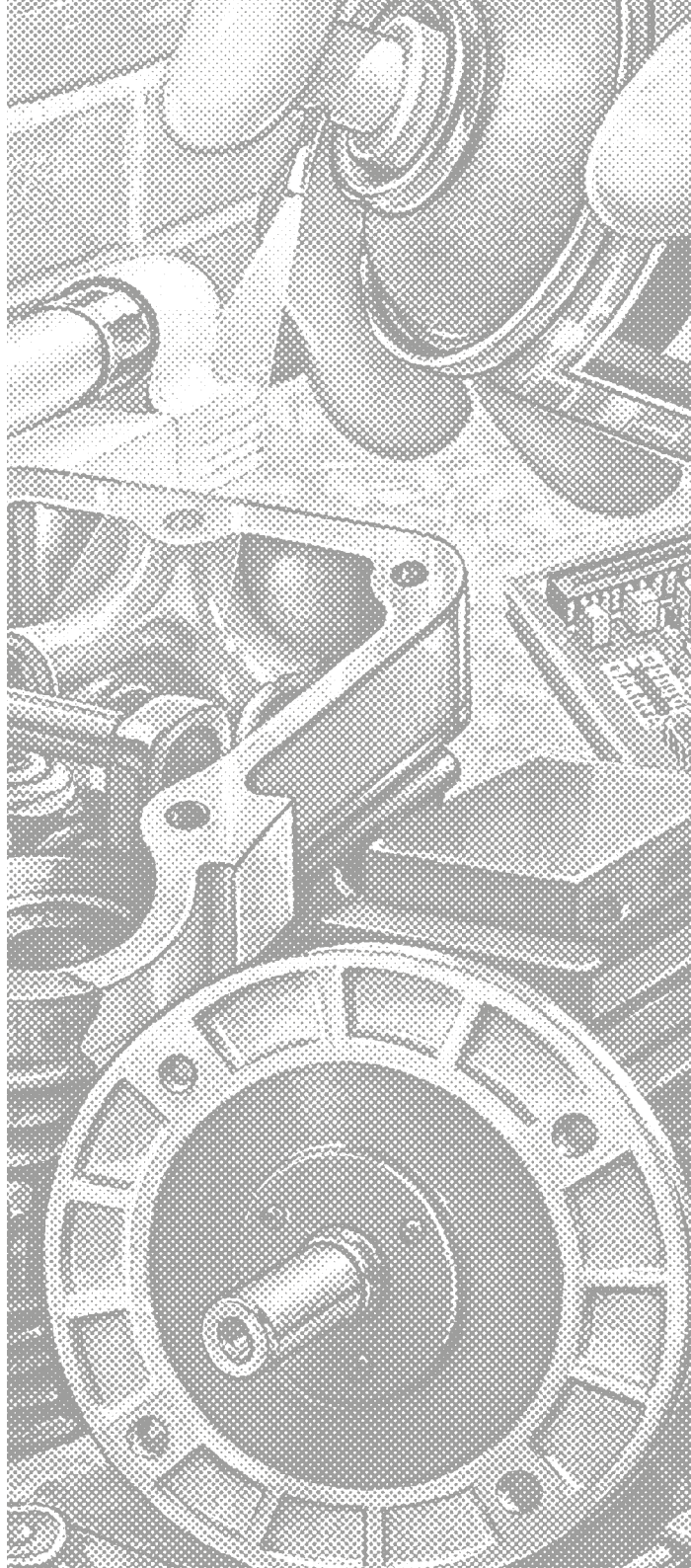

TF-90 FAST DRYING CLEANING SOLVENT



KEY FEATURES

- Degreases metal surfaces, bearings and chains quickly and effectively
- Rapid evaporation with zero residue
- Removes oils, greases, waxes and cutting lubricants
- Ideal pre-painting, bonding and sealing cleaner
- Good materials compatibility
- Ideal for degreasing metal surfaces in preparation for painting and for removing welders anti-spatter and cutting lubricants

APPLICATION AREAS

TF-90 is used as a general engineering solvent degreaser on bearings, chains, guides, metal components and machinery. A highly effective surface-preparation solvent to clean surfaces prior to painting, bonding or coating. Can also be used to remove anti-spatter and metal cutting oil from finished pieces.

MARKET SECTORS:

ENGINEERING

TRADE/PRO-DIY

ELECTRICAL MRO

AGRICULTURE

FASTENERS & FIXINGS

CRC CODE	SIZE	PER BOX
33322	500ml Aerosol TwinSpray	15
32774	500ml Aerosol	15

For further product info:
www.actioncan.com/product/tf-90/

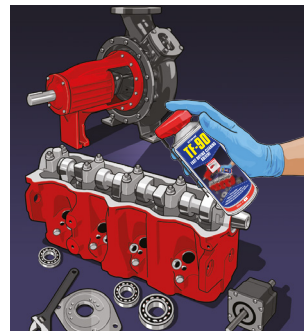

CLEANERS

AMAZE DASH & BUMPER CLEANER



KEY FEATURES

- Cleans and restores vehicle dashboards, interior plastics and rubber trims
- Anti-static to help keep all surfaces dust free
- Pleasant, fresh fragrance
- Easy to use: spray and wipe

APPLICATION AREAS

Designed for use on vehicle dashboards, interior plastic trim, bumpers or on any plastic surface where a shine is required.

MARKET SECTORS:

- ENGINEERING**
- AGRICULTURE**
- TRADE/PRO-DIY**

CRC CODE	SIZE	PER BOX
32867	500ml Aerosol	15

For further product info:
www.actioncan.com/product/amaze/ 



BC-90 BRAKE AND CLUTCH CLEANER



KEY FEATURES

- Powerful solvent cleaner for brake and clutch parts
- Fast drying and does not leave a residue
- Quickly removes grime, brake dust, dirt, fluids/oils and contaminants
- Can be used as a general purpose degreaser for maintenance

APPLICATION AREAS

Use BC-90 for the degreasing and cleaning of brake linings, drums, cylinders, brake shoes, disc brake pads, discs, wedge brakes, springs, callipers and clutch discs.

MARKET SECTORS:

- ENGINEERING**
- TRADE/PRO-DIY**
- AGRICULTURE**

CRC CODE	SIZE	PER BOX
32770	500ml Aerosol	15

For further product info:
www.actioncan.com/product/bc-90/ 

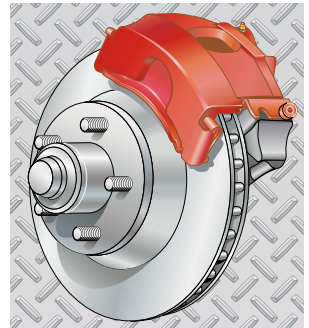

BLUE CRYSTAL GLASS & HARD SURFACE CLEANER



KEY FEATURES

- Multi-purpose cleaner for use on glass, plastic, ceramic tiles, metal and many hard surfaces
- Ready to use in a handy trigger spray
- Fast and easy cleaning with anti-static additive to reduce dust build-up
- Smear and streak free, crystal-clear finish

APPLICATION AREAS

Especially effective glass cleaner. Ideal for use on shiny and gloss surfaces that require cleaning. Excellent materials compatibility: aluminium, chrome, fibreglass, glass, linoleum, metals, mirrors, plastics, polished metals, stainless steel and steel.

MARKET SECTORS:

- AGRICULTURE**
- ENGINEERING**
- TRADE/PRO-DIY**

CRC CODE	SIZE	PER BOX
32878	750ml Trigger Bottle	12

For further product info:
www.actioncan.com/product/blue-crystal/

DS-90 MULTI-SURFACE DECONTAMINATION SPRAY



KEY FEATURES

- Extremely high alcohol content: >80%
- Tested according to EN1276, EN1650 & EN14476 (product is not classified as a biocide)
- Physically removes bacteria, viruses and fungus
- Multi-functional decontamination spray
- Leaves treated surfaces clean, dry & residue free
- Easy to use: spray & go
- Evaporates quickly, with no need to rinse with water or a cloth

APPLICATION AREAS

Removes contamination from most surfaces, including: metal, fabrics & most plastics.

MARKET SECTORS:

- TRADE/PRO-DIY**
- FASTENERS & FIXINGS**
- ELECTRICAL MRO**
- AGRICULTURE**
- ENGINEERING**

CRC CODE	SIZE	PER BOX
33341	500ml Aerosol	15

For further product info:
www.actioncan.com/product/ds-90/

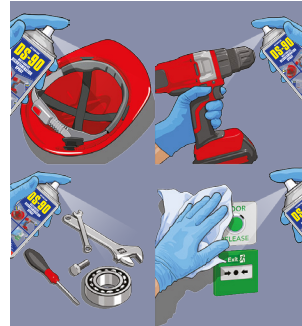

EC-90 FAST DRYING CONTACT CLEANER



KEY FEATURES

- Cleans delicate electronic and electrical components
- Removes deposits and tarnish from switches and contacts
- Rapidly evaporates and does not leave a residue
- Safe for use on all metals, most rubbers, plastics and coatings
- Non-conductive and corrosion resistant

APPLICATION AREAS

Use on electric motor contacts and windings, generator and transformer windings, electrical parts, switch-gear, fuses and high-tension contacts.

MARKET SECTORS:

- ELECTRICAL MRO**
- ENGINEERING**
- TRADE/PRO-DIY**
- AGRICULTURE**

CRC CODE	SIZE	PER BOX
32777	500ml Aerosol	15

For further product info:
www.actioncan.com/product/ec-90/ 

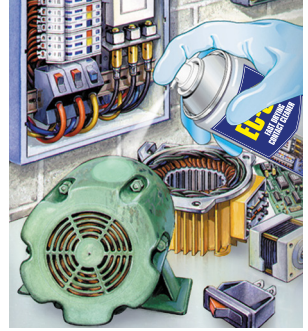

FC-90 ANTI-STATIC FOAM CLEANER



KEY FEATURES

- Highly effective multi-surface cleaner
- Penetrates into soiling and gently lifts grime and dirt
- Fresh apple fragrance
- Controlled foam breakdown for best results
- Safe for use on plastics, metals, glass and a wide range of materials

APPLICATION AREAS

Suitable for use on office machines and equipment, domestic appliances, work surfaces, walls, facility machinery, cabinets, casings and vinyl. Do not spray directly into computer keyboards or on screens.

MARKET SECTORS:

- TRADE/PRO-DIY**
- ENGINEERING**
- ELECTRICAL MRO**
- FASTENERS & FIXINGS**
- AGRICULTURE**

CRC CODE	SIZE	PER BOX
32803	500ml Aerosol	15

For further product info:
www.actioncan.com/product/fc-90/ 



IPA ELECTRONIC CLEANING SOLVENT



KEY FEATURES

- Very 'safe' and gentle solvent cleaner
- Removes light oil, flux residue, and electronics contamination
- Excellent materials compatibility
- Fast evaporation and residue free
- Removes moisture
- IPA purity $\geq 99.7\%$
- Conforms to BS1595, ASTM 0770 and DIN53245

APPLICATION AREAS

A 'universally safe' solvent cleaner with excellent materials compatibility. Use on printed circuit boards, optical equipment, lenses, precision instruments and other delicate components.

MARKET SECTORS:

- ELECTRICAL MRO**
- ENGINEERING**
- TRADE/PRO-DIY**
- AGRICULTURE**

CRC CODE	SIZE	PER BOX
32778	500ml Aerosol	15

For further product info:
www.actioncan.com/product/ipa/ 



CLEANERS

LW-90 PROFESSIONAL MULTI-PURPOSE WIPES



KEY FEATURES

- Professional-grade wipes for the removal of general soiling, grease residue, light oils, paints, sealant & more
- Multi-purpose: use on hands, tools and even as a hard surface cleaner
- Ideal for use where washroom facilities are not available
- Wipe size: 195mm x 300mm
- Tub contains 90 wipes

APPLICATION AREAS

Multi-purpose professional wipes that quickly remove lubricants, tar, sealants, heavy grease, oils, wax, paint, adhesives, ink, caulk and much more from hands, tools and surfaces.

MARKET SECTORS:

- TRADE/PRO-DIY**
- ENGINEERING**
- FASTENERS & FIXINGS**
- ELECTRICAL MRO**
- AGRICULTURE**

CRC CODE	SIZE	PER BOX
32874	90 Extra Large Sheets	6

For further product info:
www.actioncan.com/product/lw-90/ 



PD-90 POWER DUSTER

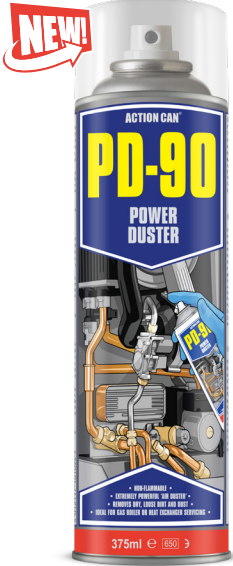

KEY FEATURES

- Extremely powerful dry blast, high discharge duster
- Non-flammable
- Instantly removes dry, loose dirt and dust from hard to reach areas
- Low GWP of 6

APPLICATION AREAS

PD-90 is the ideal solution to cleaning dust from gas burner jets on domestic, commercial, and industrial boilers, improving burn efficiency. The powerful w'air' blast instantly cleans dry contamination from fine surfaces, such as heat exchangers, cooling fins and fans, as well as all hard to reach areas. PD-90 is the essential tool for HVAC engineers.

MARKET SECTORS:

ENGINEERING
TRADE/PRO-DIY
ELECTRICAL MRO

CRC CODE	SIZE	PER BOX
33310	375ml Aerosol	15

For further product info:
www.actioncan.com/product/pd-90/

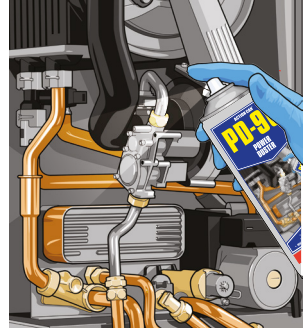

CLEANERS

SC-90 STAINLESS STEEL CLEANER



KEY FEATURES

- 3-in-1 Foaming Stainless Steel Cleaner – Cleans, Protects and Polishes
- A white foam cleaner that clings to vertical surfaces
- Long-lasting shine and non-greasy polished finish
- Cleans and removes grime easily
- Protects against dirt attraction, fingerprints and watermarks
- Specially designed for cleaning stainless steel, chrome plating, powder-coated surfaces and aluminium
- NSF A7 and C1 registered for use in the food and beverage sector

APPLICATION AREAS

Ideal after-maintenance cleaner to remove contamination and leave work area clean. Can be used in the food and beverage sector as a stainless steel surface cleaner and polish, removing finger marks, contamination and water-marks.

MARKET SECTORS:

ENGINEERING **TRADE/PRO-DIY**
FASTENERS & FIXINGS

CRC CODE	SIZE	PER BOX
32792	500ml Aerosol	15

For further product info:
www.actioncan.com/product/sc-90/

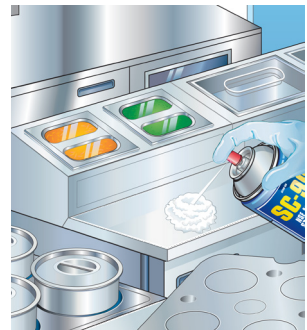

TW-90 HEAVY DUTY TEXTURED WIPES



KEY FEATURES

- Textured multi-purpose wipes for professionals
- Highly absorbent, locks in grime
- Removes grease, oil, sealant, silicone, and grime
- Quick drying, low odour & non-sticky
- Contains anti-bacterial protection & effective against Weils Disease
- Tub contains 100 wipes

APPLICATION AREAS

TW-90 can be used for a deep cleaning on hands, tools or surfaces. It removes difficult contaminants such as adhesive, gasket residue, bitumen, silicone, ink, oil, grease, lubricants & paint. Perfect for mobile or remote workers, such as service engineers, construction workers and utility contractors.

MARKET SECTORS:

- TRADE/PRO-DIY**
- AGRICULTURE**
- FASTENERS & FIXINGS**
- ENGINEERING**

CRC CODE	SIZE	PER BOX
33314	100 Extra Large Sheets	4

For further product info:
www.actioncan.com/product/tw-90/



CLEANERS

METAL WORKING

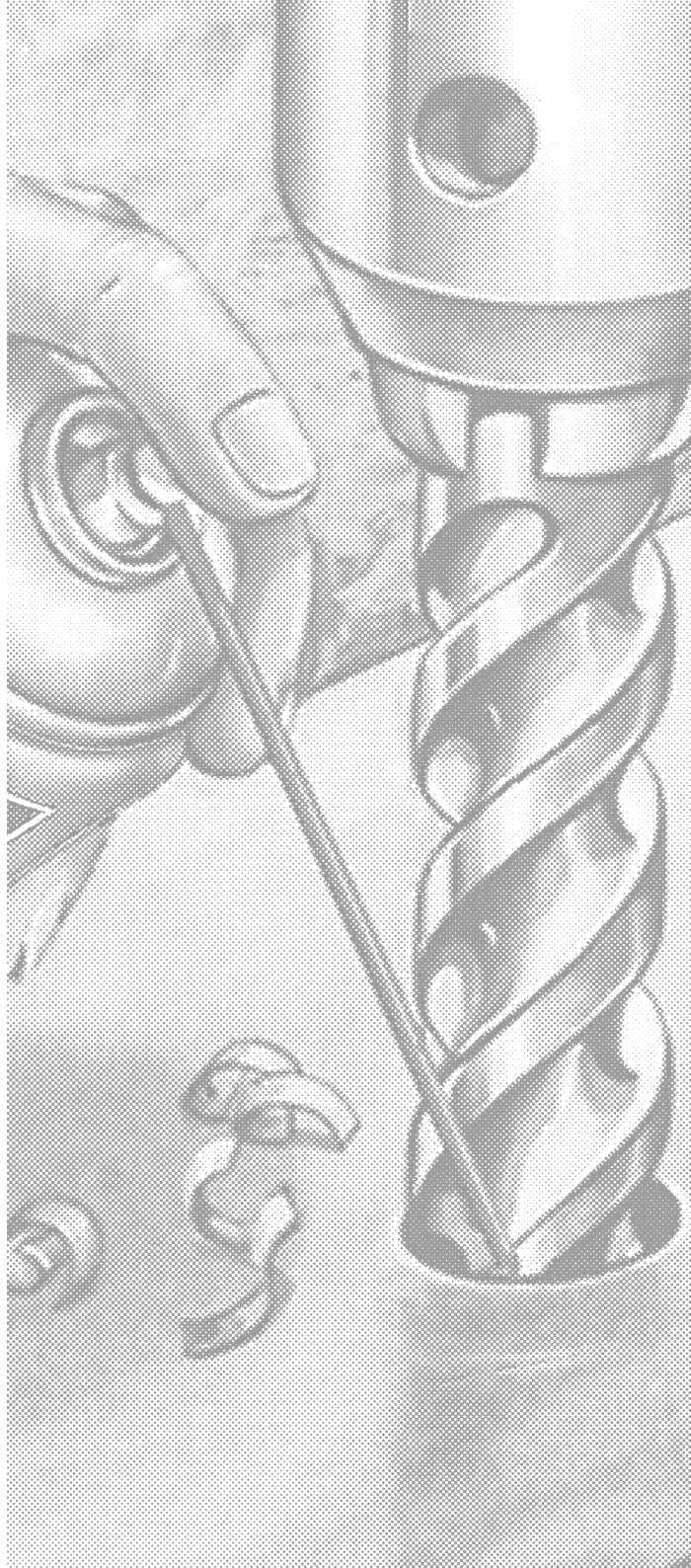

CT-90 CUTTING AND TAPPING FLUID



KEY FEATURES

- Versatile, multi-metal cutting, tapping, drilling and reaming lubricant
- Reduces friction and cutting time
- Improves surface finish
- Extends tool life
- Dissipates heat and reduces swarf build-up

APPLICATION AREAS

All types of stainless steels, carbon steels and Nimonic alloys. Can also be used as a deep drawing, blanking or piercing lubricant. Convenient easy to apply, for precise application control, and hard-to-reach areas. Ideal for mobile engineers and operators working off-site.

MARKET SECTORS:

- FASTENERS & FIXINGS**
- ENGINEERING**
- TRADE/PRO-DIY**
- ELECTRICAL MRO**
- AGRICULTURE**

CRC CODE	SIZE	PER BOX
33324	500ml Aerosol TwinSpray	15
32772	500ml Aerosol	15
32972	400ml Foaming Aerosol	15
32865	5L Bulk Can	1
32862	500ml Bottle with spout	12
32861	480g Compound Tub	12

For further product info:
www.actioncan.com/product/ct-90/ 



METAL WORKING

AS-90 WELDERS ANTI-SPATTER SPRAY



KEY FEATURES

- 3-in-1 welders fluid: anti-spatter, wire feed lubricant and post-weld corrosion inhibitor
- Non-flammable CO₂ propellant
- Easy "wipe off" removal
- Does not contain silicone
- Economical and easy to use

APPLICATION AREAS

Prevents spatter adhesion to equipment and surfaces. Use on resistance welding tips, Mig and Tig tips, weldments, electrode holders, contact tips, tools, metal moulds and bench top splash guards. Also works as an effective wire lubricant and anti-corrosion treatment.

MARKET SECTORS:

FASTENERS & FIXINGS
ENGINEERING
AGRICULTURE

CRC CODE	SIZE	PER BOX
32761	400g Aerosol	15

For further product info:
www.actioncan.com/product/as-90/

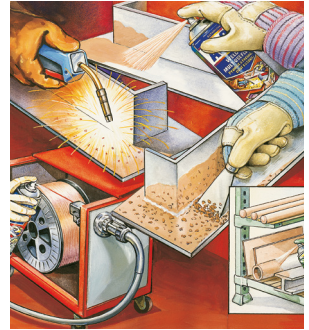

METAL WORKING

FF-90 FLAW FINDER NON-DESTRUCTIVE TESTING KIT



KEY FEATURES

- FF-90 Cleaner:**
- Powerful, rapid dry solvent
 - Removes grime & contamination
 - Use for accurate results
- FF-90 Penetrant:**
- Highly visible red dye for NDT
 - Identifies defects $\geq 30\mu\text{m}$
 - Excellent materials compatibility
- FF-90 Developer:**
- High contrast, opaque white powder
 - Clearly indicates defects in welds
 - Easily removed after inspection

APPLICATION AREAS

FF-90 can be used to inspect welds, castings and forging. As well as use in: fabrication and metal work, pressure vessels, rolling mill products, repair facilities, metal alloy plates, metal parts and components, valves and fittings, boilers, furnaces and engines, machining, composite manufacturing and construction for structural components.

MARKET SECTORS:

ENGINEERING **AGRICULTURE**

CRC CODE	SIZE	PER BOX
33317	NDT Kit	3
33311	500ml Aerosol FF-90 Cleaner	-
33312	500ml Aerosol FF-90 Penetrant	-
33313	500ml Aerosol FF-90 Developer	-

For further product info:
www.actioncan.com/product/ff-90/



WB-90 WATER BASED ANTI-SPATTER SPRAY



KEY FEATURES

- Non-toxic water-based film preventing weld spatter adhesion
- Easy clean up: no chiselling, grinding, buffing or brushing
- Free from silicone and oil: will not interfere with post weld applications: galvanising, painting, or powder coating
- Contains anti-corrosion additives: prevents flash rusting
- No solvents, low odour and non-flammable

APPLICATION AREAS

Recommended for use on all welding applications. For use on welding equipment such as welding tips, Mig and Tig tips, Arc welding, weldments, electrode holders, contact tips, tools, metal moulds and bench top splash guards.

MARKET SECTORS:

FASTENERS & FIXINGS

ENGINEERING

AGRICULTURE

CRC CODE	SIZE	PER BOX
33281	500ml Aerosol	15

For further product info:

www.actioncan.com/product/wb-90/ 



ANTI-CORROSION & PAINTS

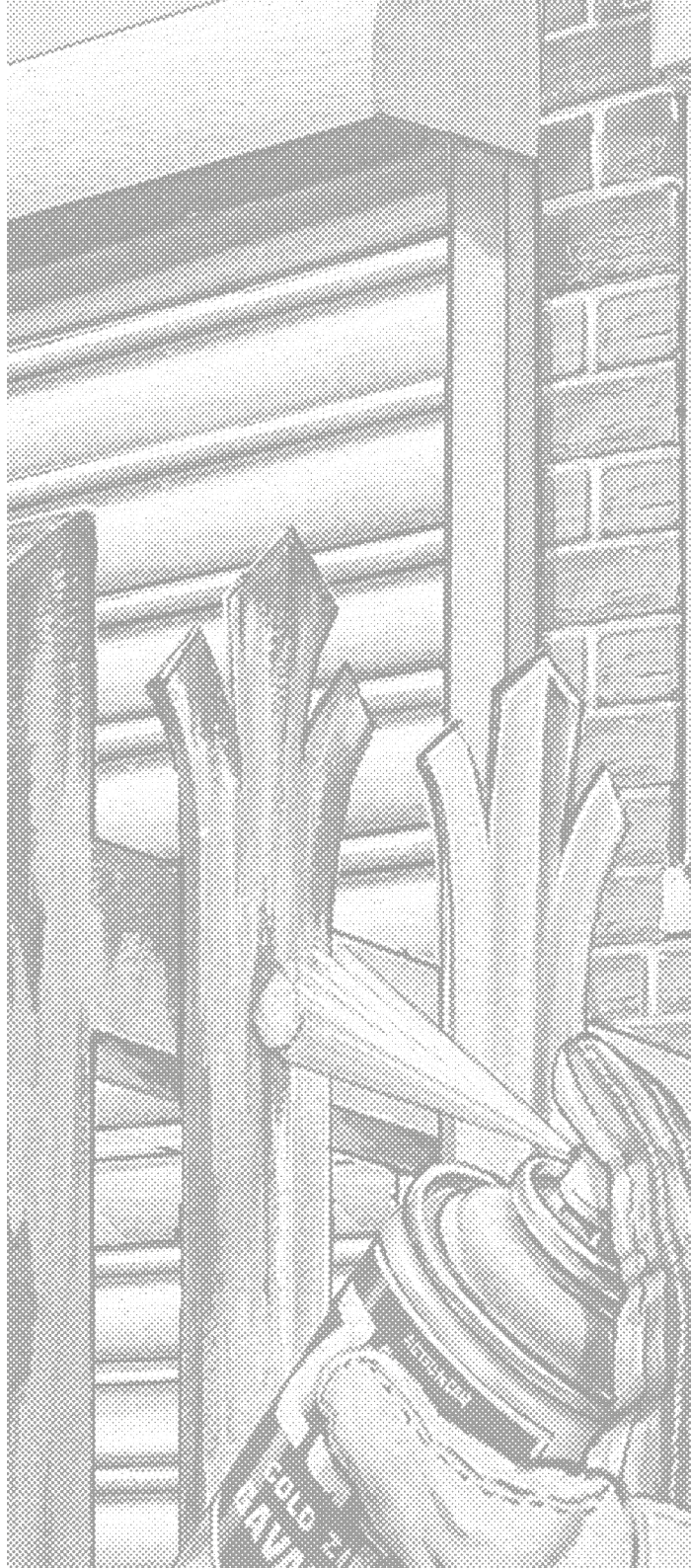

ZG-90 RAPID DRY GALVANISE

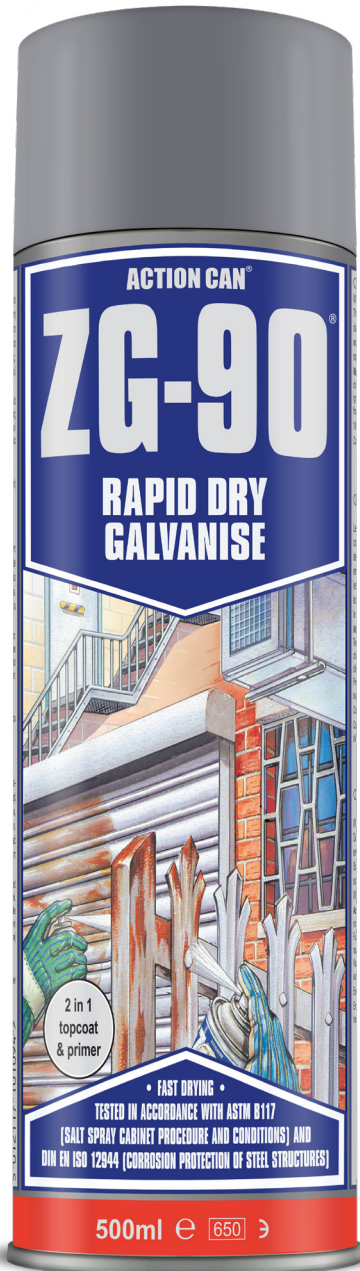

KEY FEATURES

- ZG-90 Silver (Rapid drying time: Touch dry in 2 mins/Hard dry in 20 mins at 20°C)
- Excellent colour-match for freshly hot-dip galvanised steel
- Effective protection against corrosion (tested to ASTM B117)
- Passes ISO 12944-2, Category C3
- Crossrail approval #CRL-MCR-004850
- Non-conductive
- Also available as RAL-matched colours (2-in-1 topcoat + primer, satin finish)

APPLICATION AREAS

- Fastener specialists: use to protect bolted joints on steel sections and girders. Avoid the need to re-plate a bolt or stud, spray ZG-90 on exposed bolts and threaded bar to match existing zinc plating or galvanised coating.
- General fabrication: Use on bare, degreased metal to provide an effective, colour-matched finish with good long-term protection.
- Facility Maintenance: repairing and maintaining fences, metal sheets that are used on air conditioning units and ducting.
- Electrical and mechanical contractors: spray ZG-90 cut ends of Unistrut type channelling and cable conduit

MARKET SECTORS:

AGRICULTURE

ELECTRICAL MRO

FASTENERS & FIXINGS

ENGINEERING

TRADE/PRO-DIY

CRC CODE	SIZE	PER BOX
32811	500ml Aerosol Silver Rapid Dry Galvanise	15
32813	500ml Aerosol Satin Finish Black [RAL 9005]	15
32817	500ml Aerosol Satin Finish White [RAL 9010]	15
32814	500ml Aerosol Satin Finish Green [RAL 6010]	15
32819	500ml Aerosol Satin Finish Red [RAL 3000]	15
32818	500ml Aerosol Satin Finish Blue [RAL 5012]	15
32820	500ml Aerosol Satin Finish Yellow [RAL 1004]	15
33205	900ml Tin Silver	6
33206	900ml Tin Black	6

For further product info:

www.actioncan.com/product/zg-90/

ANTI-CORROSION & PAINTS

MZ-90 MAXIMUM ZINC COATING

KEY FEATURES

- Matt Grey: more zinc = more protection
- Can be welded through
- Touch-dry in 40 minutes
- Forms a hard, flexible film that strongly resists flaking, cracking, peeling, and damage
- MZ-90 provides even greater protection when used as a base coat with our popular ZG-90
- Provides cathodic anti-corrosion protection that meets ISO 1461:1999

APPLICATION AREAS

Long-lasting, effective, protection for steel structures such as gantries, hand-rails, mezzanine floor supports, structural steel and ferrous metals exposed to high corrosion conditions. Can also be used to protect cut surfaces/exposed steel in fasteners, conduit, strapping, welds, fencing, railings, grates, electrical poles, breaker panel housings, rain spouts, signs, doors, trailers and guard rails.

MARKET SECTORS:

AGRICULTURE | ELECTRICAL MRO
FASTENERS & FIXINGS
ENGINEERING | TRADE/PRO-DIY

CRC CODE	SIZE	PER BOX
32810	500ml Aerosol	15

For further product info:
www.actioncan.com/product/mz-90/



ANTI-CORROSION & PAINTS

RX-90 RED OXIDE ANTI-RUST PRIMER

KEY FEATURES

- Protective anti-corrosion coating with zinc complexes to withstand harsh outdoor conditions
- Primer for ferrous metals such as bare steel and iron surfaces
- Excellent adhesion to rusty surfaces
- Fast drying
- Can be welded through

APPLICATION AREAS

Engineering – structural steel, gantries, outside equipment and machinery.

Agriculture – tank stands, fences, gates, animal raceways in milking sheds and yards, farm machinery and tractor drawbars.

Trade/Pro-DIY – railings, roofing and spouting, gutters, outdoor fixtures, fences and gates.

MARKET SECTORS:

AGRICULTURE
ENGINEERING
TRADE/PRO-DIY

CRC CODE	SIZE	PER BOX
32809	500ml Aerosol	15

For further product info:
www.actioncan.com/product/rx-90/

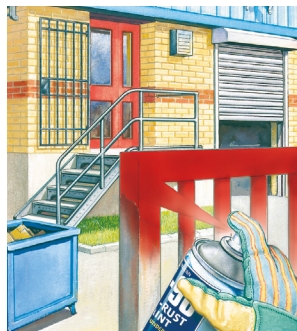

SUPERTROL ANTI-RUST FLUID

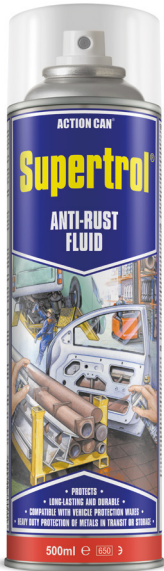

KEY FEATURES

- Heavy-duty, long-term protection against rust
- Excellent penetrating and spread: total protection
- Displaces atmospheric and surface moisture on contact
- Dries to a soft, flexible film
- Does not contain silicone

APPLICATION AREAS

Protects equipment and machinery in long-term storage and between production cycles. Safeguard valuable cutting tools, dies and equipment. Protects machined steels and all precision ground surfaces. Use to protect internal/hidden automotive surfaces.

MARKET SECTORS:

- AGRICULTURE
- FASTENERS & FIXINGS
- ENGINEERING
- TRADE/PRO-DIY

CRC CODE	SIZE	PER BOX
32800	500ml Aerosol	15

For further product info:
www.actioncan.com/product/supertrol/ 

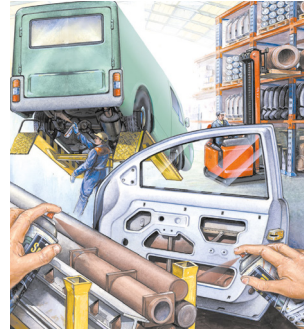

ANTI-CORROSION & PAINTS

WORKSHOP ADDITIONS

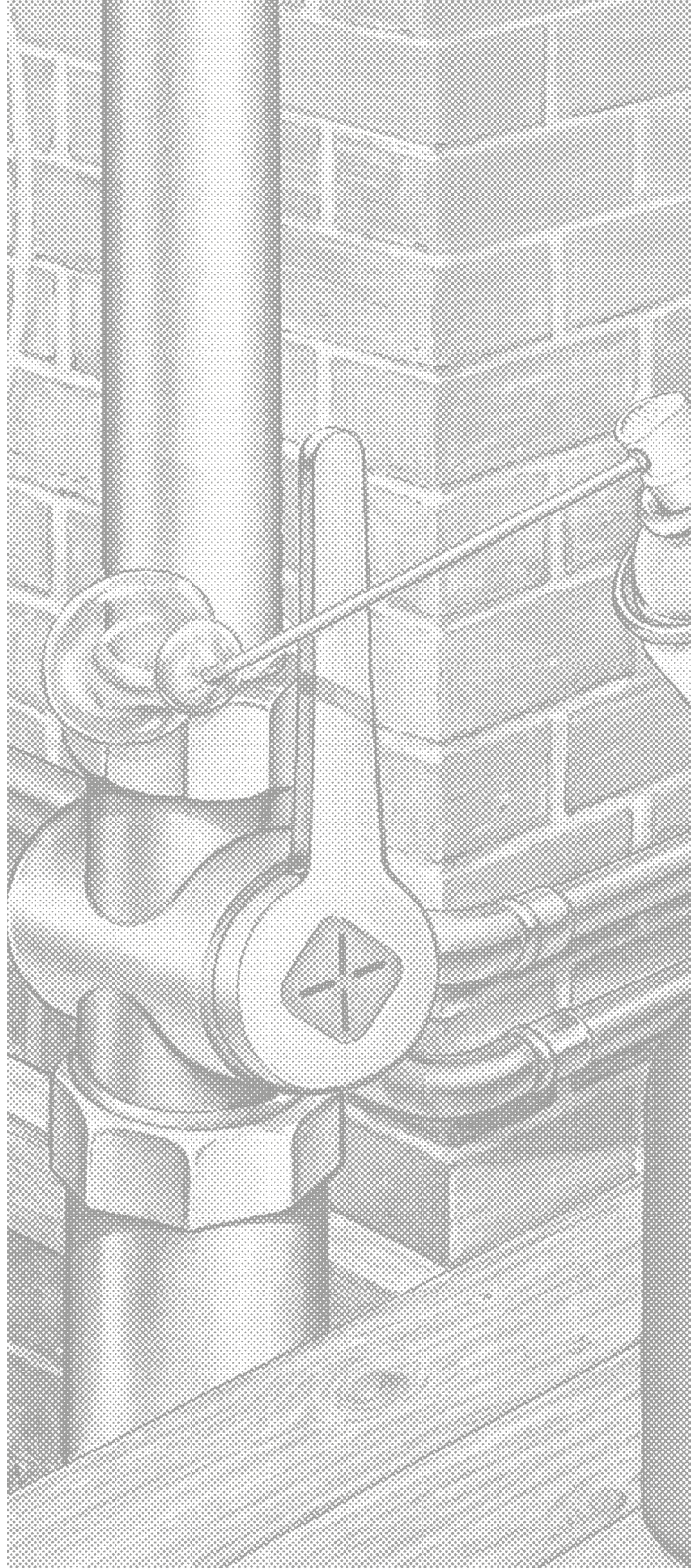

LD-90 GAS LEAK DETECTOR



KEY FEATURES

- Economical gas leak detector used on all types of gases (including O₂)
- Highlights leaks even on low-pressure systems
- Non-flammable, water-based formula
- Conforms to BS EN 14291:2004 (VOSA MOT Testing) and MIL-L-25567 for oxygen system compatibility
- Does not contain solvents, silicone or oils

APPLICATION AREAS

LD-90 is a perfect gas leak detection tool in multiple industries: gas fitting, plumbing, heating, automotive air conditioning, engineering and welding, HVAC, QC tests, maintenance and safety checks on pipework, air lines, joints, valves, cylinders, regulators, air brakes and inflatable equipment.

MARKET SECTORS:

ENGINEERING
TRADE/PRO-DIY

CRC CODE	SIZE	PER BOX
33173	500ml Aerosol	15

For further product info:
www.actioncan.com/product/as-90/

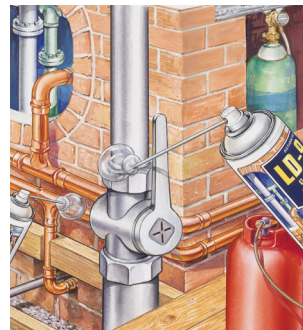

WORKSHOP ADDITIONS

AT-90 AIR TOOL LUBRICANT



KEY FEATURES

- Protects and lubricates all pneumatic tools, valves and air lines
- Extends tool life and promotes smoother start up and running
- Anti-foaming and anti-gumming additives to maximise tool performance
- Effective cleaning oil that penetrates and remove grime and contamination, improving tool performance
- Formulated with rust inhibitors to protect tools from corrosion
- ISO Viscosity Grade 22

APPLICATION AREAS

Use as a multi-purpose lubricating and anti-corrosion oil for all air tools such as impact wrenches, sanders, grinders, air motors, hammers, drills, air power tools, in-line lubrication, and more. Apply directly to tools as a protective treatment during storage or as an in-line lubricant during tool use.

MARKET SECTORS:

ENGINEERING
AGRICULTURE

CRC CODE	SIZE	PER BOX
32881	500ml Bottle with spout	12

For further product info:
www.actioncan.com/product/at-90/

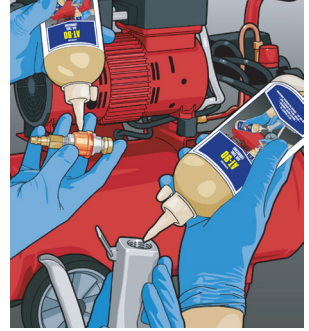

LM-90 LINE MARKING PAINT



KEY FEATURES

- A quick-drying, highly durable, line marking paint
- Fits all popular application machines: easy to apply
- Multi-use paint suitable for: civil engineering, construction, warehouse, car parks/pavements, and utilities
- A range of popular bright colours: Yellow, White, Red, Blue, Green, Orange and Black

APPLICATION AREAS

Suitable for use on concrete, asphalt, wood, and grass/soil for the identification of gas, water and electrical supplies.

MARKET SECTORS:

AGRICULTURE
TRADE/PRO-DIY

CRC CODE	SIZE	PER BOX
32824	750ml Aerosol Yellow [RAL 1018]	12
32825	750ml Aerosol White [RAL 9003]	12
32826	750ml Aerosol Red [RAL 3018]	12
32827	750ml Aerosol Blue [RAL 5015]	12
32828	750ml Aerosol Green [RAL 6018]	12
32829	750ml Aerosol Orange [RAL 2003]	12
32830	750ml Aerosol Black [RAL 9004]	12

For further product info:
www.actioncan.com/product/lm-90/

SA-90 CONTACT SPRAY ADHESIVE



KEY FEATURES

- Heavy duty multi-purpose contact spray adhesive
- Strong, flexible bond
- Easy to use with precise positioning capability
- Adjustable spray pattern minimises overspray
- Coverage approximately 3–5m²
- Non-chlorinated

APPLICATION AREAS

Use SA-90 for bonding automotive upholstery, trim and foam backed carpet, carpet tiles, displaying signage, and paper/card. Suitable for use on all metals, wood, ceramic and cork.

MARKET SECTORS:

- AGRICULTURE**
- ELECTRICAL MRO**
- FASTENERS & FIXINGS**
- ENGINEERING**
- TRADE/PRO-DIY**

CRC CODE	SIZE	PER BOX
32806	500ml Aerosol	15

For further product info:

www.actioncan.com/product/sa-90/



WORKSHOP ADDITIONS

GLOSSARY

ADD

The Aerosol Dispensers Directive is a piece of European legislation, the primary purpose of which is to protect the consumer and end-user safety about the use of aerosol dispensers. Amongst other criteria, ADD requires that all filled aerosols are tested to ensure complete integrity (water bath testing to 50°C) and that all formulations are thoroughly tested to evaluate potential flammability – and labelled accordingly. With the addition of the compliance mark (the reversed epsilon 'ε') located on the aerosol can itself, consumers can confirm that the aerosol has been tested to rigorous EU standards.

AEROSOL

A self-contained sprayable product comprising a mixture of active ingredients, carriers and propellant contained in a steel or aluminium container which discharges the formulation under pressure. Aerosols are hermetically sealed, ensuring the risk of spillage is removed, storage simplified, and combustion risks minimised - all benefiting Health & Safety guidelines. Aerosols assist with the precise and controlled application.

BARRIER PROTECTION

Barrier protection is one of two primary methods of protecting metals from corrosion. By coating the metal with a suitable product (e.g. MZ-90, ZG-90, Supertrol), corrosion is unable to take place because electrolytes (such as rainwater) are unable to come into contact with the metal and electron flow cannot be established, thus preventing galvanic corrosion.

BIODEGRADATION/BIODEGRADABLE

The process by which organic substances are broken down into harmless constituents by the natural action of living micro-organisms.

CATHODIC PROTECTION

Cathodic protection is based on the ionic charge of the metal and the reversal or mitigation of the flow of electrons as found in galvanic corrosion. The protective coating applied should have a lower potential (volts) than the metal it is to protect so that the coating is corroded in preference to the base metal – with protection often extending beyond the physical edge of the coating. By offering itself for corrosion instead of the base metal, this type of coating is often termed 'sacrificial' and is how galvanised steel is protected.

DIELECTRIC STRENGTH

The maximum electric field strength that an insulating material can withstand intrinsically without decomposing, usually specified in volts per millimetre of thickness. Also known as the breakdown voltage.

EMULSION

A combination of water-soluble and water-insoluble chemical groups held together by a surfactant. Emulsions are usually milky white.

EP ADDITIVES

EP Additives are "Extreme Pressure" resistant additives that are used to fortify the base lubricant (whether oil or grease). These EP additives may take many forms but are typically solids with physical properties which enhance lubricity under high loads and challenging conditions. Examples of "EP Additives" are PTFE, MoS₂, and Graphite".

EVAPORATION RATE

The rate at which a material will vaporise (evaporate) when compared to the known rate of vaporisation of a standard material. The designated standard material is usually n-butyl acetate, with a vaporisation rate designated as 1.0. The higher the number, the faster the evaporation rate.

FDA

The FDA (Food and Drugs Administration) ensures that all ingredients used in foods are safe, and that food is free of contaminants such as disease-causing organisms, chemicals, or other harmful substances. The FDA reviews the results of laboratory, animal and human clinical testing conducted by companies to determine if the product they wish to place on the market is safe and effective. The FDA does not develop or test products itself, nor issue approvals'.

FLASHPOINT

The lowest temperature at which the vapours of a solvent will flash (ignite) under specific test conditions.

GALLING

The process by which metal components 'cold weld' and seize. When two metals are brought together under pressure, the action of forcing the surfaces together can cause the contacting faces to begin to combine at an atomic level, fusing the pieces together. Where the stainless steel or aluminium alloys are used, the friction can scour off the thin, non-reactive protective oxide layer, exposing clean reactive material - allowing atomic fusing to occur. Galling can be prevented using a lubricant, such as bearing grease. However, grease needs to be 'worked' before full lubrication is achieved. Therefore, a running-in paste should be used to prevent galling in this start-up period.

GALVANIC CORROSION

Electrochemical process which occurs when two metals with different electrical potentials are in contact with each other in the presence of an electrolytic solution (such as rainwater).

GALVANISING

Galvanising is the process by which clean, degreased ferrous metal (i.e. steel) has a layer of zinc applied to its surface using extreme heat to form an inseparable alloy at the point where the two layers are fused.

Zinc will be corroded in preference to the ferrous substrate thereby preventing structural corrosion. This type of coating is referred to as a 'sacrificial coating'.

GHS/CLP:

The Classification, Labelling and Packaging (CLP) Regulation implements the UN Global Harmonised System (GHS) in all EU member states. Currently, there are several different pieces of legislation relating to the classification, labelling and packaging of dangerous substances worldwide. GHS will implement same criteria for classifying chemicals according to the health, environmental and physical hazards; and for how hazards are communicated via product labels and MSDS's. Manufacturers will need to plan the phase-in of complete label and packaging (print) re-design; the updating of all MSDS's and the communication of these changes through the channel. These changes will include the introduction of new hazard warning pictograms and harmonised warning and precautionary statements on labels, which will replace the existing risk and safety phrases.

GLOSSARY

HAZARD SYMBOLS

PHYSICAL HAZARD



Extremely flammable aerosol

Flammable aerosol

Highly flammable liquid and vapour

Flammable liquid and vapour

HEALTH HAZARD



Serious Health Hazard



Health Hazard



Corrosive

ENVIRONMENTAL HAZARD



Hazardous to the environment

ISO 9001

Internationally recognised Quality Management system standard, indicating Action Can's commitment to quality and continuous improvement. The standard has been developed to provide a framework around which a quality management system can effectively be implemented.

ISO 14001

Internationally recognised environmental management standard. Specifies the requirements for an environmental management system; provides a framework for an organisation to control the environmental impacts of its activities, products and services, and to improve its environmental performance continually.

KB VALUE

The Kauri-Butanol (KB) value is a measure of the relative solvent power of a hydrocarbon liquid. The higher the KB value, the more powerful the solvent.

MOLYBDENUM DISULPHIDE/MoS₂/MOLY

Molybdenum disulphide, MoS₂ or 'moly' for short, is an inorganic compound similar in appearance and feel to graphite. It is widely used as a dry-film lubricant due to its low friction and resistant to extreme pressures. Moly can be used by itself as a dry lubricant as well as an EP additive for lubricating oils, greases, and pastes. Moly also benefits from very good resistance to solvents, providing a tenacious lubricating film.

MRO

Abbreviation for the term "Maintenance, Repair, and Overhaul". Typically associated with the service and repair sectors, including plant and site maintenance/engineering.

NLGI GRADE

A widely used classification for lubricating greases established by the National Lubricating Grease Institute and a reference to the measure of the consistency of a particular grease. The most common consistency number is #2. Softer grades, especially #0 and #1, are often used for improved low-temperature service. High consistency numbers, #3 through #6 used for specific high-speed bearings where leakage and sealing are particular concerns. The higher the number, the more viscous the grease.

NSF EXPLAINED

NSF is an abbreviation for the National Sanitation Foundation, founded in 1944 as a not-for-profit, non-governmental organisation. NSF International is a global provider of public health and safety risk management solutions to companies, governments and consumers. In 1999, it launched its voluntary Non-food Compounds Registration Program to re-introduce the previous authorisation program administered by the U.S. Department of Agriculture (USDA).

Product evaluation based on the formulation, and label review and products which comply with the relevant regulations and guidelines receive a Letter of Authorisation and are included in the 'NSF White Book™'.

NSF CATEGORIES

A1

Acceptable for use as a general cleaner on all surfaces in and around food processing areas, where its use is not intended for direct food contact. All food products and packaging materials must be removed or protected before product use. After use of this product, rinse surfaces with potable water. The cleaner should not exhibit a noticeable odour nor leave a visible residue.

H1

This product is acceptable as a lubricant with incidental food contact for use in and around food processing areas. Such compounds may be used on food processing equipment as a protective anti-rust film, as a release agent on gaskets or seals of tank closures, and as a lubricant for machine parts and equipment in locations in which there is a potential exposure of the lubricated part to food. If used as an anti-rust film, the compound must be removed from the equipment surface, leaving the surface effectively free of any substance which could be transferred to food.

A7

Acceptable as a metal cleaner and polisher for non-food contact surfaces (A7) in and around food processing areas. All food products and packaging materials shall be removed or carefully protected prior to usage. This compound must be used in a manner so that all odours associated with the compound are dissipated before food products or packaging materials are re-exposed in the area.

GLOSSARY

C1

Acceptable for use in inedible product processing areas, non-processing areas, and/or exterior areas of food processing establishments provided that it is not used to mask odours resulting from unsanitary conditions, and that any characteristic odour or fragrance does not penetrate into an edible product area. When used on equipment that will be returned to a food processing area, the product must be completely washed off and rinsed with potable water before returning to the processing area.

OZONE DEPLETERS

Halogen-containing substances known to reduce the protective effects of the stratospheric ozone layer. Aerosols manufactured within Europe have been free of ozone-depleting substances for many years. Action Can products have not contained CFC's or other ozone depleters since 1985.

pH

A scale ranging from 0 to 14 used to measure acidity and alkalinity. The lower the number, the more acidic; the higher the number, the more alkaline; 7 is neutral.

POTABLE WATER

The water of sufficient quality to serve as drinking water is called potable water whether it is used as such or not. Although most fresh water sources are drinkable by humans, they can be a disease vector or cause long-term health problems if they do not meet certain water quality guidelines.

PTFE

The abbreviation for polytetrafluoroethylene, PTFE, appears in the Guinness Book of Records as having the lowest coefficient of static and dynamic friction of any solid.

This value, at 0.02, is equivalent to wet ice on wet ice, indicating its extreme anti-friction properties.

REACH

Registration, Evaluation and Authorisation of Chemicals. REACH is an EU-wide reform of the regulatory environment in which chemicals are used and will eventually replace and update many other pieces of chemical control legislation.

The aim is to reduce the risks to human health and the environment through the methodical and accurate identification of the properties of chemical substances. While there is no definitive list of 'approved' chemicals yet, a series of deadlines will ensure that the highest volume and most harmful are evaluated first. REACH relies on end-user application information to be filtered up through the supply chain to establish accurate registration and evaluation.

More information can be found at www.hse.gov.uk/reach.

RAL

In 1925, the private sector and the German government founded the "Reichsausschuss für Lieferbedingungen" – RAL – (Committee of the German Reich for Terms and Conditions of Sale). RAL's original task was to standardise precise technical terms of delivery and sale. The RAL colour collection comprises over 200 colours with a four-digit numbering. The registers also include safety and signal colours, and they comply with the requirements of the DIN standards (German Industrial Standards). The basic collection of matt colour shades is the register RAL 840 HR while it is the RAL 841 GL register for gloss colours. RAL 840 HR is the European-wide "registered" standard colours for the coatings industry.

SHELL 4-BALL WELD

An industry standard test which indicates the load bearing capability of a lubricant. A steel ball is loaded and rotated against three fixed steel balls for 10 seconds. At the end of each 10-second run, a further weight is loaded onto the balls, and the test re-run using fresh lubricant. The test is complete when the balls weld together. The weld point is the load at which this occurs. The higher the weld point, the greater the lubricity (lubricating ability) of the grease.

SURFACTANT

A descriptive term derived from 'Surface Active Agent', a specialised compound that is typically used to connect water soluble and water insoluble chemical groups. Can be used to improve the emulsifying, foaming, dispersing and wetting properties of a product.

THIXOTROPIC

A term used to describe fluids which are shear thinning. Most thixotropic substances are gel-like, meaning that they retain their shape upon application, but when heated or subjected to shear stress, their shape will change, and they will become thinner. The word comes from the Greek 'thixis' for touch and 'tropy', from 'tropos' meaning changeable.

TESTING METHODS

ASTM B 117 94 is a specification covering the operating conditions for a salt spray chamber. Basically, the test pieces are subjected to a continuous salt spray mist at 35°C. The salt solution used to generate the mist contains 5% Sodium chloride.

ASTM D 1654 (procedure B) is a specification which details a method for evaluating the area of surface corrosion present on a test plate. A test grid template divided into 1% squares is held over the plate to assist in establishing a value for the total surface area corrosion.

BS EN 14291:2004 relates to foam producing leak detection products for use on gas installations.

DIN EN ISO 12944 is an extensive spec designed to cover the evaluation of the corrosion protection offered to steel structures by paints or coatings. It's divided into 8 parts. The -1 suffix at the end of the number simply refers to part 1 of the spec which is entitled "General Introduction". Parts 2 to 8 cover the test procedures and conditions in more detail.

MIL-L-25567 is a US military spec covering leak detection liquids with particular reference to their compatibility with pure oxygen systems.

ACTION CAN[®]

By CRC Industries

AEROSOLS FOR...



FASTENERS & FIXINGS



ENGINEERING



TRADE & PRO-DIY



AGRICULTURE & CONSTRUCTION



ELECTRICAL MRO

ACTION CAN[®]

By CRC Industries 

Your Action Can Distributor:

LinkedIn

Follow us on LinkedIn

www.linkedin.com/company/action-can



Follow us on Twitter

@ActionCanPRO

Action Can,

Wylds Road, Bridgwater,
Somerset, TA6 4DD, England

Phone: +44 (0)1278 727200

Email: sales.uk@crcind.com

Company Reg. No: 4910479

VAT No. GB 821 5196 42



WWW.ACTIONCAN.COM